

HANDLING EQUIPMENT





CHAIN CONVEYOR | 600 T/H - 1500 T/H | ROMANIA



BUCKET ELEVATOR | 600 T/H | UKRAINE



CHAIN CONVEYOR | 300 T/H | ITALY



BUCKET ELEVATOR | 500 T/H | UK



TRIPPER FOR VESSEL LOADING
1500 T/H | ROMANIA



BUCKET ELEVATOR | 500 T/H | UK



FLIGHT CONVEYOR | 300 T/H | ALGERY



FLAT WAREHOUSE BELT CONVEYOR TNM.1000.630 | 500 T/H | PARAGUAY

Vision

In 2020, AGI PTM and AGI FRAME merged, creating AGI EMEA, the business and manufacturing headquarters for AGI in Europe, the Middle East and Africa. With three updated, state-of-the-art manufacturing facilities in Bologna Italy, AGI EMEA delivers custom systems and solutions across seven components; storage, handling, processing, structures, technology, project management and engineering.

With over 30 years of experience in grain storage and handling, AGI EMEA is one of Europe's largest and most respected manufactures of all types of corrugated steel silos for commercial and agricultural applications. Their complete catalog includes, catwalks, ladders, platforms, bucket elevators, chain conveyors, temperature sensing, sweeps, weighing, bagging and dryers. From the first design, to manufacturing and installation, customers trust AGI EMEA to partner with on their projects around the world.

Company Profile

AGI PTM is a leading manufacturer of Handling Equipment for Grain Storage and Processing.

Product range includes bucket elevators, chain conveyors and belt conveyors. Handling capacity ranges from 20 to 2000 t/h.

AGI PTM's experience and skilled team of in-house engineers make for the right partner. AGI PTM delivers solutions across a range of applications and industries including; storage and mechanization of port installations to serving industry grain traders, millers, feed-mills, pelletizers, bio-fuel processing plants, engineering companies and contractors around the world.

AGI PTM machines have been installed throughout 34 countries, operating in different climate conditions, and serving industries and products such as:

- Cereals (wheat – maize – barley – rice)
- Oilseeds (soybean – sunflower – rape)
- Flour for human consumption and Feed for livestock
- Malt & Grits
- Pellets - DDGS
- By-products (bran – waste)
- Wood (chips – pellets – sawdust)
- Inert products and chemicals

01

Chain Conveyors

02

Open Belt Conveyors

03

Bucket Elevators

04

Flight Conveyors

05

Ancillaries

06

Valves, Gates and Spouting

07

Engineering



Chain Conveyors

[M] LINE HEAVY DUTY

M Line Chain Conveyors are designed for high capacity and heavy-duty applications.

Handling capacity goes from 50 t/h, suitable for milling solutions or medium storage plants, up to 1200 t/h to guarantee the maximum performances for commercial facilities, processing plants and port terminals.

MAIN FEATURES

- Hot dip galvanization in compliance with standard EN ISO 1461
- Welded flanges for case stiffening, easy alignment and assembly
- Bent-link scraper chains - drop forged chains (*)
- Powder coating surface finishing for milling applications (*)
- AR steel bottom and sides lining (*)
- HDPE bottom lining (*)
- AR steel chain guide (*)
- Split-sprocket for drop forged chain (*)
- Chain break switch (*)
- Bearing temperature sensors (*)
- CE certification
- ATEX certification for installation in zone classified 22 (*)



Driving Head

- Direct coupling with free-maintenance steel-disk-spring damping system
- Geared motor unit with fluid-coupling, flexible joint and swing base (*)
- Driving head sprocket with hardened teeth
- Anti-clogging system and inspection window
- Self-cleaning drive head ("drum" type) (*)

Tail

- Standard screw take-up
- Tensioning slides with self-aligning bearings
- Speed monitoring system
- Tensioning system with disk spring (*)
- Special execution for reversible machine (*)
- Special execution for self-cleaning (*)
- Dust-tight (*)

Casing

- Simple and robust design, easy-to-assemble made with bolted panels
- Standard casings - bypass/side-inlet casings - double deck casings - elbow casing
- HDPE chain sliding tracks with steel central guide

Accessories (*)

- Standard inlet hopper
- Inlet hopper with flow regulation (manual control)
- Side inlet hopper
- Discharging hopper (symmetrical or asymmetrical design, square or round outlet)
- Discharging slide gates
- Magnetic separator with stainless steel outlet hopper
- Adjustable supporting legs
- Inspection windows

OPTIONS (*)

01 CHAIN CONVEYORS

TECHNICAL SPECIFICATIONS

| MODEL | CAPACITY ⁽¹⁾ t/h | MAIN DIMENSIONS | | | | | | | | DRIVING HEAD | | | CASING | | | TAIL | | |
|--------------|--------------------------------|-----------------|----------------------|---------|---------|----------------------|---------|----------------------|---------|--------------|--------------|-------------|-------------|--------------|-------------|-------------|--------------|-------------|
| | | W mm | W ₁ mm | H mm | A mm | A ₁ mm | B mm | B ₁ mm | C mm | Sides mm | Bottom mm | Cover mm | Sides mm | Bottom mm | Cover mm | Sides mm | Bottom mm | Cover mm |
| TCM.320.160 | 40 | 160 | 230 | 330 | 1000 | 330 | 700 | 330 | 1095 | 3,0 | 3,0 | 1,5 | 2,5 | 3,0 | 1,5 | 3,0 | 3,0 | 1,5 |
| TCM.320.200 | 60 | 200 | 270 | 330 | 1000 | 330 | 700 | 330 | 1130 | 3,0 | 3,0 | 1,5 | 2,5 | 3,0 | 1,5 | 3,0 | 3,0 | 1,5 |
| TCM.400.200 | 80 | 200 | 316 | 420 | 1250 | 450 | 750 | 450 | 1300 | 5,0 | 4,0 | 2,0 | 3,0 | 4,0 | 2,0 | 3,0 | 4,0 | 2,0 |
| TCM.400.250 | 100 | 250 | 370 | 420 | 1250 | 450 | 750 | 450 | 1320 | 5,0 | 4,0 | 2,0 | 3,0 | 4,0 | 2,0 | 3,0 | 4,0 | 2,0 |
| TCM.400.300 | 120 | 300 | 416 | 420 | 1250 | 450 | 750 | 450 | 1360 | 5,0 | 4,0 | 2,0 | 3,0 | 4,0 | 2,0 | 3,0 | 4,0 | 2,0 |
| TCM.400.350 | 150 | 350 | 465 | 420 | 1250 | 450 | 750 | 450 | 1380 | 5,0 | 4,0 | 2,0 | 3,0 | 4,0 | 2,0 | 3,0 | 4,0 | 2,0 |
| TCM.400.400 | 200 | 400 | 515 | 420 | 1250 | 450 | 750 | 450 | 1410 | 5,0 | 4,0 | 2,0 | 3,0 | 4,0 | 2,0 | 3,0 | 4,0 | 2,0 |
| TCM.440.350 | 200 | 350 | 465 | 510 | 2000 | 620 | 1000 | 510 | 1635 | 6,0 | 6,0 | 2,0 | 4,0 | 6,0 | 2,0 | 5,0 | 6,0 | 2,0 |
| TCM.440.400 | 250 | 400 | 515 | 510 | 2000 | 620 | 1000 | 510 | 1660 | 6,0 | 6,0 | 2,0 | 4,0 | 6,0 | 2,0 | 5,0 | 6,0 | 2,0 |
| TCM.550.400 | 250 | 400 | 525 | 610 | 2000 | 710 | 1000 | 600 | 1670 | 6,0 | 6,0 | 3,0 | 4,0 | 6,0 | 3,0 | 5,0 | 6,0 | 3,0 |
| TCM.550.450 | 300 | 450 | 575 | 610 | 2000 | 710 | 1000 | 600 | 1700 | 6,0 | 6,0 | 3,0 | 4,0 | 6,0 | 3,0 | 5,0 | 6,0 | 3,0 |
| TCM.550.500 | 350 | 500 | 625 | 610 | 2000 | 710 | 1000 | 600 | 1810 | 6,0 | 6,0 | 3,0 | 4,0 | 6,0 | 3,0 | 5,0 | 6,0 | 3,0 |
| TCM.630.450 | 400 | 450 | 575 | 660 | 2000 | 715 | 1000 | 650 | 1785 | 6,0 | 6,0 | 3,0 | 5,0 | 6,0 | 3,0 | 5,0 | 6,0 | 3,0 |
| TCM.630.500 | 500 | 500 | 625 | 660 | 2000 | 715 | 1000 | 650 | 1810 | 6,0 | 6,0 | 3,0 | 5,0 | 6,0 | 3,0 | 5,0 | 6,0 | 3,0 |
| TCM.630.600 | 600 | 600 | 725 | 660 | 2000 | 715 | 1000 | 650 | 1860 | 6,0 | 6,0 | 3,0 | 5,0 | 6,0 | 3,0 | 5,0 | 6,0 | 3,0 |
| TCM.800.600 | 700 | 800 | 740 | 830 | 2750 | 890 | 1250 | 825 | 2020 | 6,0 | 8,0 | 3,0 | 5,0 | 8,0 | 3,0 | 5,0 | 8,0 | 3,0 |
| TCM.800.800 | 800 | 800 | 940 | 835 | 2750 | 890 | 1250 | 835 | 2150 | 6,0 | 8,0 | 3,0 | 5,0 | 8,0 | 3,0 | 5,0 | 8,0 | 3,0 |
| TCM.800.1250 | 1000 | 1250 | 1390 | 845 | 2750 | 890 | 1250 | 845 | 1960 | 6,0 | 8,0 | 3,0 | 5,0 | 8,0 | 3,0 | 6,0 | 8,0 | 3,0 |
| TCM.800.1400 | 1200 | 1400 | 1390 | 900 | 2750 | 890 | 2000 | 900 | 3150 | 6,0 | 8,0 | 3,0 | 5,0 | 8,0 | 3,0 | 6,0 | 8,0 | 3,0 |

(1) Capacity based on dry cereal (m.c. 14%) - bulk density 0,78 t/m³ - impurities < 4%
 Inclined with elbow casing : l=5°/10° - (for l>10° see Flight Conveyors line up to 45°)
 Totally inclined up to 15°
 (*) Variable (Standard lengths = 2970 / 2470 / 1980 / 1470 / 990 / 490 - Other lengths available upon request)

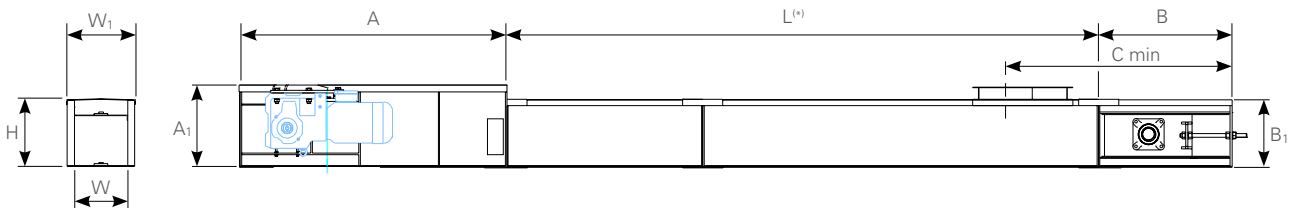

Chain Conveyors

[A] LINE MEDIUM DUTY

A Line Chain Conveyors are designed for applications from 20 t/h up to 300 t/h.

These conveyors are the best solution for both small storages and seasonal traders with higher demand.

Featuring a strong and light design, A Line equipment equipment is the result of many years of continuous engineering improvements and optimizations. After collecting feedback and advice from our customers, we've confirmed the best solution to meet their crop and grain handling operations.

MAIN FEATURES

- Continuously hot-dip coated Z275 according to EN 10346
- Bent flanges for case stiffening, easy alignment and assembly
- Bent-link scraper chains
- AR steel bottom and sides lining (*)
- HDPE bottom lining (*)
- Split-sprocket for drop forged chain (*)
- Chain break switch (*)
- Bearing temperature sensors (*)
- CE ertification
- ATEX certification for installation in zone classified 22 (*)



UP TO
300 t/h
CAPACITY

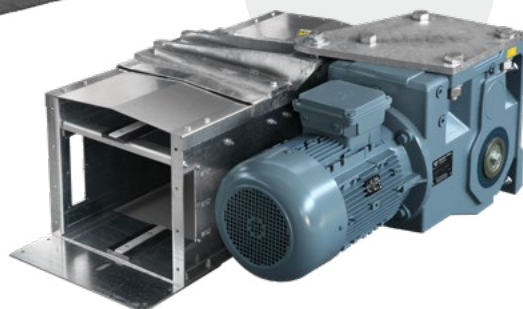

OPTIONS (*)

Driving Head

- Direct coupling with free-maintenance steel-disk-spring damping system
- Driving head sprocket with hardened teeth
- Anti-clogging system and inspection window

Tail

- Standard screw take-up
- Tensioning slides with self-aligning bearings
- Speed monitoring system
- Special execution for reversible machine (*)

Casing

- Easy-to-assemble bolted panels
- Standard casings - bypass/side-inlet casings - double deck casings - elbow casing for inclination changing
- HDPE chain sliding track with steel central guide

Accessories (*)

- Standard inlet hopper
- Side inlet hopper
- Discharging hopper (symmetrical or asymmetrical design, square or round outlet)
- Discharging slide gates
- Magnetic separator with stainless steel outlet hopper
- Adjustable supporting legs
- Aspiration hoppers
- Inspection windows

01 CHAIN CONVEYORS

TECHNICAL SPECIFICATIONS

| MODEL | CAPACITY ⁽¹⁾ t/h | MAIN DIMENSIONS | | | | | | | | DRIVING HEAD | | | CASING | | | TAIL | | |
|---------|--------------------------------|-----------------|----------------------|---------|---------|----------------------|---------|----------------------|---------|--------------|--------------|-------------|-------------|--------------|-------------|-------------|--------------|-------------|
| | | W mm | W ₁ mm | H mm | A mm | A ₁ mm | B mm | B ₁ mm | C mm | Sides mm | Bottom mm | Cover mm | Sides mm | Bottom mm | Cover mm | Sides mm | Bottom mm | Cover mm |
| TCA.60 | 60 | 200 | 290 | 345 | 750 | 360 | 750 | 345 | 985 | 3,0 | 3,0 | 1,5 | 2,5 | 3,0 | 1,5 | 3,0 | 3,0 | 1,5 |
| TCA.120 | 120 | 300 | 390 | 345 | 750 | 360 | 750 | 345 | 1035 | 3,0 | 3,0 | 1,5 | 2,5 | 3,0 | 1,5 | 3,0 | 3,0 | 1,5 |
| TCA.150 | 150 | 350 | 450 | 445 | 1000 | 445 | 750 | 445 | 1300 | 4,0 | 4,0 | 2,0 | 3,0 | 4,0 | 2,0 | 4,0 | 4,0 | 2,0 |
| TCA.200 | 200 | 400 | 500 | 445 | 1000 | 445 | 750 | 445 | 1350 | 4,0 | 4,0 | 2,0 | 3,0 | 4,0 | 2,0 | 4,0 | 4,0 | 2,0 |
| TCA.250 | 250 | 520 | 620 | 450 | 1250 | 450 | 750 | 450 | 1350 | 4,0 | 4,0 | 2,0 | 3,0 | 4,0 | 2,0 | 4,0 | 4,0 | 2,0 |
| TCA.300 | 300 | 500 | 605 | 575 | 1600 | 660 | 900 | 660 | 1600 | 4,0 | 4,0 | 2,0 | 4,0 | 4,0 | 2,0 | 4,0 | 4,0 | 2,0 |

(1) Capacity based on dry cereal (m.c. 14%) - bulk density 0,78 t/m³ - impurities < 4%

Inclined with elbow casing : l=5°/10° - (l>10° see Flight Conveyors line up to 45°)

Totally inclined up to 15°

(*) Variable (Standard Lengths = 2900 / 2400 / 1900 / 1400 / 900 / 400 - Other lengths available upon request)

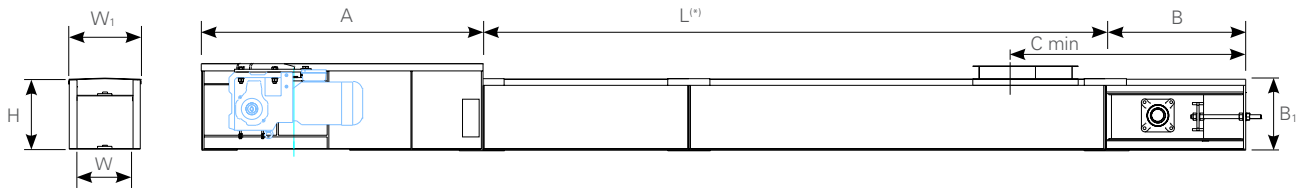

Open Belt Conveyors

[M] LINE HEAVY DUTY

AGI PTM Open Belt Conveyors are engineered for a long-lasting operational life and for a gentle product handling.

The structure is entirely made in galvanized steel, with sturdy construction and top performance components make AGI PTM conveyors the right solution for a wide range of applications from local traders to larger port terminals.

You can complete the conveyor by choosing a fully customized tripper car, serving multiple discharging points along the conveyor, achieving maximum flexibility in daily operations.

MAIN FEATURES

- Hot dip galvanization in compliance with standard EN ISO 1461 and continuously hot dip coated Z275 according to EN 10346
- Gravity counterweight system for a proper and continuous take-up tensioning
- Gravity tower upgrade for counterweight continuous take-up tensioning (*)
- Reverseable conveyor execution (*)
- Cable operated safety switch on one or two (*) sides
- Bearing temperature sensors (*)
- CE certification
- ATEX certification for installation in zone classified 22 (*)



OPTIONS (*)

Driving Head

- Direct coupling with maintenance-free steel-disk-spring damping system
- Geared motor unit with fluid-coupling, flexible joint and swing base (*)
- Abrasion resistant and antistatic rubber coated drive head pulley
- AR steel lining on inlet/outlet chutes
- Metal backed urethane lining on inlet/outlet chutes (*)
- Ceramic tile lining on inlet/outlet chutes (*)
- Anti-clogging system at the discharge (*)
- Belt alignment control system

Tail

- Standard screw take-up
- Special tail for gravity tower upgrade for counterweight continuous take-up tensioning (*)
- Special execution for reversible machine (*)
- Speed monitoring system

Conveyor Stringers

- Easy-to-assemble bolted elements
- Standard stringer supports - elbow stringer supports (*)
- Modular design;

Accessories (*)

- Mobile tripper for warehouses and vessels loading
- Discharge hopper
- Stationary feed hopper
- Movable inlet hopper for jetty installation
- Adjustable supports
- Standard covering
- Belt sealing covering system for conveyor with tripper
- Discharging slide gates
- Magnetic separator with stainless steel outlet hopper
- Adjustable supporting legs
- Aspiration hoppers
- Inspection windows

02 OPEN BELT CONVEYORS

TECHNICAL SPECIFICATIONS

| MODEL | CAPACITY ⁽¹⁾ t/h | MAIN DIMENSIONS | | | | | | | HEAD THICKNESS | | STRINGER THICKNESS | | TAIL THICKNESS | |
|--------------|--------------------------------|-----------------|---------|---------|----------------------|---------|----------------------|-------------|----------------|-------------|--------------------|---------------|----------------|-------------|
| | | W mm | H mm | A mm | A ₁ mm | B mm | B ₁ mm | C min mm | Sides mm | Cover mm | Sides mm | Spacers mm | Sides mm | Cover mm |
| TNM.340.300 | 40 | 525 | 680 | 970 | 540 | 1000 | 300 | 1450 | 3,0 | 3,0 | 2,0 | 5,0 | 3,0 | 3,0 |
| TNM.340.350 | 60 | 615 | 680 | 970 | 540 | 1000 | 300 | 1450 | 3,0 | 3,0 | 2,0 | 5,0 | 3,0 | 3,0 |
| TNM.340.450 | 120 | 710 | 715 | 970 | 540 | 1000 | 300 | 1450 | 3,0 | 3,0 | 2,0 | 5,0 | 3,0 | 3,0 |
| TNM.500.600 | 150 | 955 | 1130 | 1330 | 1010 | 1750 | 430 | 1800 | 3,0 | 3,0 | 3,0 | 5,0 | 3,0 | 3,0 |
| TNM.500.650 | 200 | 1020 | 1170 | 1330 | 1010 | 1750 | 430 | 1800 | 3,0 | 3,0 | 3,0 | 5,0 | 3,0 | 3,0 |
| TNM.500.750 | 350 | 1105 | 1190 | 1330 | 1010 | 1750 | 430 | 1800 | 3,0 | 3,0 | 3,0 | 5,0 | 3,0 | 3,0 |
| TNM.630.1000 | 500 | 1530 | 1190 | 2040 | 1270 | 1500 | 710 | 3300 | 5,0 | 3,0 | 5,0 | 5,0 | 5,0 | 3,0 |
| TNM.630.1200 | 1000 | 1740 | 1240 | 2040 | 1270 | 1500 | 710 | 3300 | 5,0 | 4,0 | 5,0 | 5,0 | 5,0 | 3,0 |
| TNM.630.1500 | 1500 | 1920 | 1300 | 2040 | 1270 | 1500 | 710 | 3300 | 5,0 | 4,0 | 5,0 | 5,0 | 5,0 | 3,0 |
| TNM.630.1600 | 2000 | 2250 | 1750 | 2040 | 1450 | 1500 | 850 | 4000 | 5,0 | 4,0 | 5,0 | 5,0 | 5,0 | 3,0 |

(1) Capacity based on dry cereal (m.c. 14%) - bulk density 0,78 t/m³ - impurities < 4%
Totally inclined up to 10°

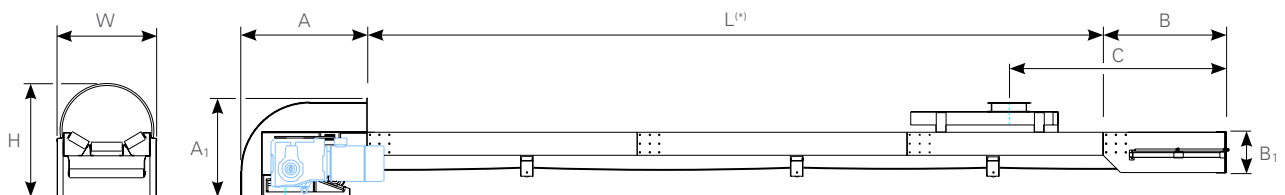

Bucket Elevators

[M] LINE HEAVY DUTY

M Line includes a wide range of Bucket Elevators designed to meet all the vertical transportation needs.

The sturdy and robust construction makes our elevators able to operate in the harshest environments.

M Line Bucket Elevators, deliver a wide range of capacities up to 1500t/h, are specifically designed for traders, commercial plants, processing plants and port terminals.

MAIN FEATURES

- Hot dip galvanization in compliance with standard EN ISO 1461
- Powder coating surface finishing for milling applications (*)
- Abrasion resistant and antistatic belt
- FDA belt (*)
- Flame retardant belt (*)
- Steel buckets - HPDE buckets (*)
- AR steel lining - urethane lining (*) - ceramic tile lining (*)
- CE certification
- ATEX certification for installation in zone classified 22 (*)
- Bearing temperature sensors (*)
- Belt alignment control system
- Anti-clogging system (*)



OPTIONS (*)

Driving Head

- Direct coupling with maintenance-free steel-disk-spring damping system
- Geared motor unit with fluid-coupling, flexible joint and swing base (*)
- Pillow block bearings (*)
- Abrasion resistant and antistatic rubber coated drive head pulley

Tail

- Standard screw take-up
- Belt take-up by means of screws and counterweight
- Self-cleaning wing tail pulley
- Speed monitoring system
- Self cleaning execution for milling application (*)

Trunking

- Easy-to-assemble bolted panels
- Standard duct - inspection duct - venting relief panel duct (*) - spotfilter duct (*)
- Round section for milling application (*)

Accessories (*)

- Extra inlet hopper
- Product recovering hopper
- Discharging hopper (square - round outlet)
- Stainless steel inlet hopper with magnetic separator
- Over pressure discharge system with chimney
- Venting relief panels at the head and/or duct
- Inspection windows
- Aspiration hopper at ducts

03 BUCKET ELEVATORS

TECHNICAL SPECIFICATIONS

| MODEL | CAPACITY ⁽¹⁾ | SELF SUPPORTING MACHINE UPTO (2) | MAIN DIMENSIONS | | | | | | | | | HEAD THICKNESS | | TAIL THICKNESS | | DUCT THICKNESS |
|----------|-------------------------|----------------------------------|-----------------|----------------|----------------|------|----------------|----------------|------|------|-----|----------------|-------|----------------|--------|----------------|
| | | | A | A ₁ | A ₂ | B | B ₁ | B ₂ | C | E | F | Sides | Cover | Sides | Slides | |
| | t/h | mt | mm | mm | mm | mm | mm | mm | mm | mm | mm | mm | mm | mm | mm | mm |
| ETM.300 | 35 | 25 | 933 | 647 | 345 | 827 | 715 | 383 | 1400 | 165 | 145 | 3,0 | 3,0 | 3,0 | 6,0 | 2,0 |
| ETM.400 | 100 | 35 | 1326 | 1038 | 476 | 1170 | 1000 | 440 | 1400 | 250 | 230 | 3,0 | 3,0 | 3,0 | 6,0 | 2,0 |
| ETM.500 | 175 | 40 | 1509 | 1059 | 693 | 1425 | 1250 | 535 | 1400 | 335 | 269 | 4,0 | 3,0 | 4,0 | 8,0 | 2,0 |
| ETM.630 | 250 | 48 | 1880 | 1364 | 860 | 1767 | 1600 | 775 | 1400 | 450 | 340 | 4,0 | 4,0 | 5,0 | 10,0 | 3,0 |
| ETM.800 | 350 | 50 | 2190 | 1597 | 970 | 2075 | 1905 | 799 | 2000 | 500 | 350 | 5,0 | 4,0 | 5,0 | 15,0 | 3,0 |
| ETM.1000 | 650 | 50 | 2377 | 1896 | 1454 | 2305 | 2000 | 1310 | 2400 | 868 | 340 | 5,0 | 5,0 | 6,0 | 15,0 | 3,0 |
| ETM.1200 | 1200 | 50 | 2589 | 2279 | 1918 | 2562 | 2150 | 1656 | 2400 | 1302 | 340 | 5,0 | 5,0 | 6,0 | 15,0 | 3,0 |
| ETM.1500 | 1500 | 50 | 2589 | 2279 | 2360 | 2562 | 2150 | 2070 | 2400 | 1736 | 340 | 5,0 | 5,0 | 6,0 | 15,0 | 3,0 |

(1) Capacity based on dry cereal (m.c. 14%) - bulk density 0,78 t/m³ - impurities < 4%

(2) Bucket Elevators are self-supporting but not freestanding. Elevators must be supported laterally (see PTM's user manual for specific model requirements)

Slides=Take-up tensioning slides

(*) Variable (Standard Lengths = 2900 / 2400 / 1900 / 1400 / 900 / 400 - Other lengths available upon request)

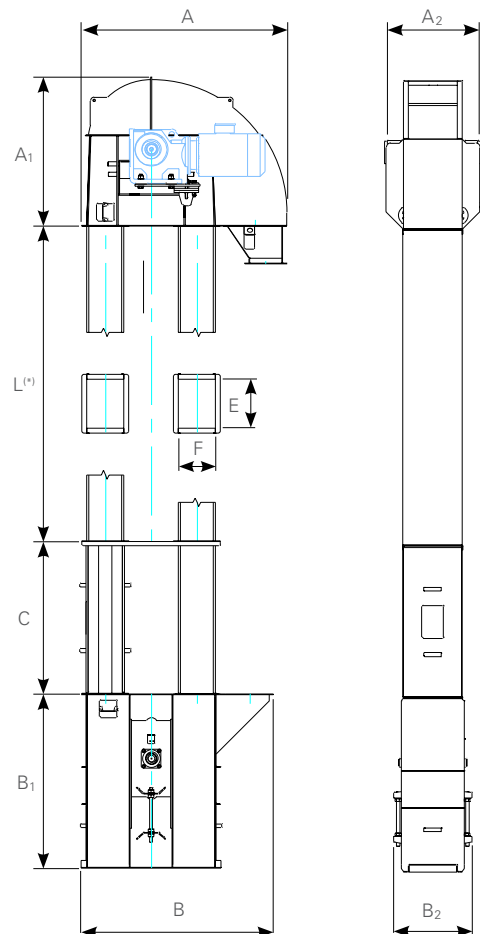

Bucket Elevators

[A] LINE MEDIUM DUTY

A Line is composed of four models of Bucket Elevators to cover capacities up to 200 t/h.

They are designed and manufactured for daily operations during harvest season.

A Line Bucket Elevators are strong, durable and provide gentle handling of commodities.

A full-range of options are available to meet customers' specific project requirements.

MAIN FEATURES

- Continuously hot-dip coated Z275 according to EN 10346
- Abrasion resistant and antistatic belt
- FDA belt (*)
- Flame retardant belt (*)
- Steel buckets - HPDE buckets (*)
- AR steel lining - urethane lining (*)
- CE certification
- ATEX certification for installation in zone classified 22 (*)
- Bearing temperature sensors (*)
- Belt alignment control system
- Anti-clogging system (*)



UP TO
200 t/h
CAPACITY



Driving Head

- Direct coupling with free-maintenance steel-disk-spring damping system
- Abrasion resistant and antistatic rubber coated drive head pulley

Tail

- Standard screw take-up
- Self-cleaning wing tail pulley
- Speed monitoring system

Trunking

- Bolted leg ducts with stiffening bends
- Standard duct - inspection duct - venting relief panel duct (*) - spotfilter duct (*)

Accessories (*)

- Extra inlet hopper
- Product recovering hopper
- Discharging hopper (square - round outlet)
- Venting relief pannels at the head and/or ducts
- Inspection windows

OPTIONS (*)

03 BUCKET ELEVATORS

TECHNICAL SPECIFICATIONS

| MODEL | CAPACITY ⁽¹⁾ | | MAIN DIMENSIONS | | | | | | | | | HEAD THICKNESS | | TAIL THICKNESS | | DUCT THICKNESS |
|---------|-------------------------|----|-----------------|----------------------|----------------------|---------|----------------------|----------------------|---------|---------|---------|----------------|-------------|----------------|--------------|----------------|
| | t/h | mt | A mm | A ₁ mm | A ₂ mm | B mm | B ₁ mm | B ₂ mm | C mm | E mm | F mm | Sides mm | Cover mm | Sides mm | Slides mm | mm |
| ELA.400 | 50 | 35 | 1246 | 1215 | 446 | 1260 | 1000 | 440 | 1400 | 250 | 240 | 3,0 | 3,0 | 3,0 | 6,0 | 2,0 |
| ELA.470 | 100 | 32 | 1467 | 1021 | 453 | 1341 | 1200 | 509 | 1400 | 267 | 261 | 3,0 | 3,0 | 3,0 | 8,0 | 2,0 |
| ELA.500 | 150 | 40 | 1605 | 1485 | 632 | 1460 | 1300 | 542 | 1400 | 350 | 280 | 3,0 | 3,0 | 3,0 | 8,0 | 2,0 |
| ELA.550 | 200 | 40 | 1756 | 1295 | 643 | 1595 | 1404 | 645 | 1400 | 373 | 291 | 4,0 | 4,0 | 4,0 | 10,0 | 3,0 |

(1) Capacity based on dry cereal (m.c. 14%) - bulk density 0,78 t/m³ - impurities < 4%

(2) Bucket Elevators are self-supporting but not freestanding. Elevators must be supported laterally (see PTM's user manual for specific model requirements)

Slides=Take-up tensioning slides

(*) Variable (Standard Lengths = 2900 / 2400 / 1900 / 1400 / 900 / 400 - Other lengths available upon request)

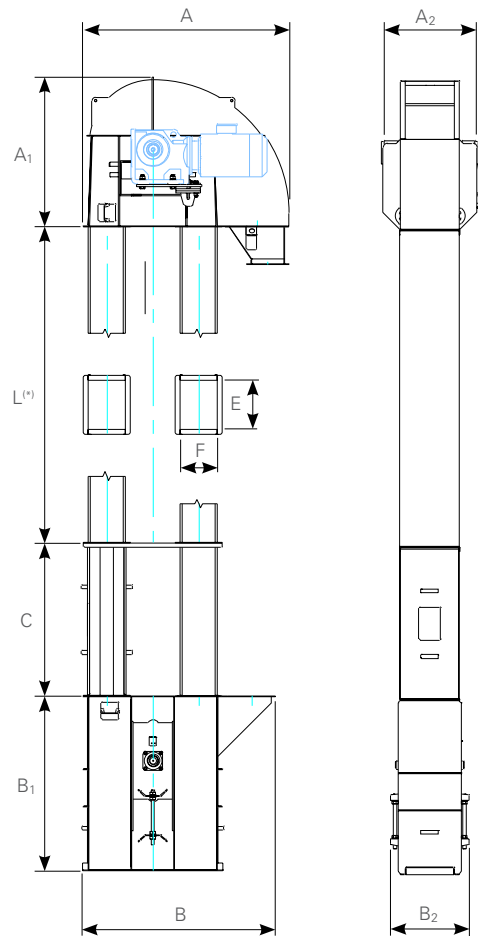

Flight Conveyors

[A]/[M] LINE HEAVY & MEDIUM DUTY

AGI PTM Flight Conveyors are manufactured with a heavy-duty construction but are also designed to provide gentle handling of commodities.

A series of large paddles made in HDPE, are designed to ensure a continuous and steady flow of material through inclines up to 45°.

Hot dip galvanization ensures maximum durability, even in the most critical operating conditions.

MAIN FEATURES

- Hot dip galvanization in compliance with standard EN ISO 1461 and continuously hot-dip coated Z275 according to EN 10346
- Bent-link scraper chains with HDPE paddles
- Powder coating surface finishing for milling applications (*)
- AR steel bottom lining (*)
- AR steel bottom and sides lining (*)
- HDPE bottom lining (*)
- HDPE bottom and AR steel sides lining (*)
- Bearing temperature sensors (*)
- CE certification
- ATEX certification for installation in zone classified 22 (*)

Driving Head

- Direct coupling with maintenance-free steel-disk-spring damping system
- Driving head sprockets with hardened teeth
- AR steel lining on discharging chutes
- Metal backed urethane lining on discharging chutes (*)
- Anti-clogging system at the discharge

Tail

- Standard screw take-up
- Take-up system with steel-disk-spring
- Take-up slides with self-aligning bearings
- Speed monitoring system

Casing

- Easy-to-assemble bolted panels
- Standard casings - bypass/side-inlet casings
- Elbow casing 15°/30°/45°
- Modular design

Accessories (*)

- Standard inlet hopper;
- Magnetic separator with stainless steel outlet hopper;
- Adjustable supports legs;
- Discharging slide gates.

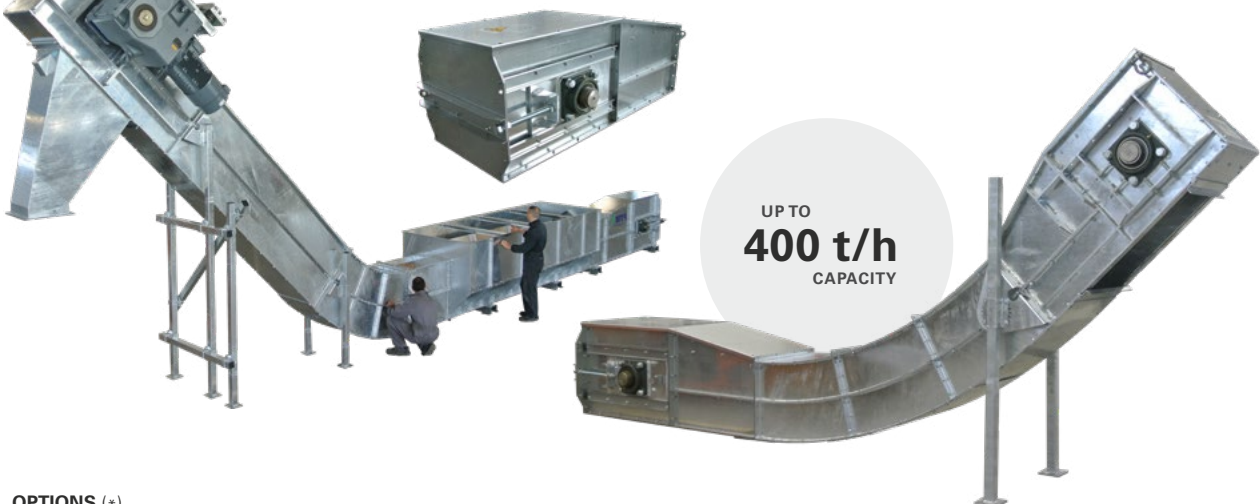

OPTIONS (*)

04 FLIGHT CONVEYORS

TECHNICAL SPECIFICATIONS

| MODEL | CAPACITY ⁽¹⁾ t/h | MAIN DIMENSIONS | | | | | | | HEAD THICKNESS | | | CASING THICKNESS | | | TAIL THICKNESS | | |
|---------|--------------------------------|-----------------|----------------------|---------|---------|----------------------|---------|----------------------|----------------|--------------|-------------|------------------|--------------|-------------|----------------|--------------|-------------|
| | | W mm | W ₁ mm | H mm | A mm | A ₁ mm | B mm | B ₁ mm | Sides mm | Bottom mm | Cover mm | Sides mm | Bottom mm | Cover mm | Sides mm | Bottom mm | Cover mm |
| TPA.50 | 60 | 250 | 345 | 445 | 1100 | 590 | 1450 | 590 | 4,0 | 4,0 | 2,0 | 3,0 | 4,0 | 2,0 | 4,0 | 4,0 | 2,0 |
| TPA.100 | 120 | 450 | 545 | 452 | 1100 | 590 | 1450 | 590 | 4,0 | 4,0 | 2,0 | 3,0 | 4,0 | 2,0 | 4,0 | 4,0 | 2,0 |
| TPA.150 | 150 | 400 | 495 | 650 | 1500 | 775 | 1500 | 770 | 4,0 | 4,0 | 2,0 | 3,0 | 4,0 | 2,0 | 4,0 | 4,0 | 2,0 |
| TPA.200 | 200 | 500 | 595 | 655 | 1500 | 780 | 1500 | 775 | 4,0 | 4,0 | 2,0 | 3,0 | 4,0 | 2,0 | 4,0 | 4,0 | 2,0 |
| TPM.300 | 300 | 500 | 630 | 930 | 2000 | 1100 | 2250 | 1100 | 6,0 | 6,0 | 3,0 | 4,0 | 6,0 | 3,0 | 6,0 | 6,0 | 3,0 |
| TPM.400 | 400 | 650 | 780 | 940 | 2000 | 1100 | 2250 | 1100 | 6,0 | 6,0 | 3,0 | 4,0 | 6,0 | 3,0 | 6,0 | 6,0 | 3,0 |

(1) Capacity based on dry cereal (m.c. 14%) - bulk density 0,78 t/m³ - impurities < 4%

(2) Standard inclinations: $i=15^\circ$; 30° ; 45°

(*) TPA Variable (Standard Lengths = 2900 / 2400 / 1900 / 1400 / 900 / 400 - Other lengths available upon request)

(*) TPM Variable (Standard Lengths = 2970 / 2470 / 1980 / 1470 / 990 / 490 - Other lengths available upon request)

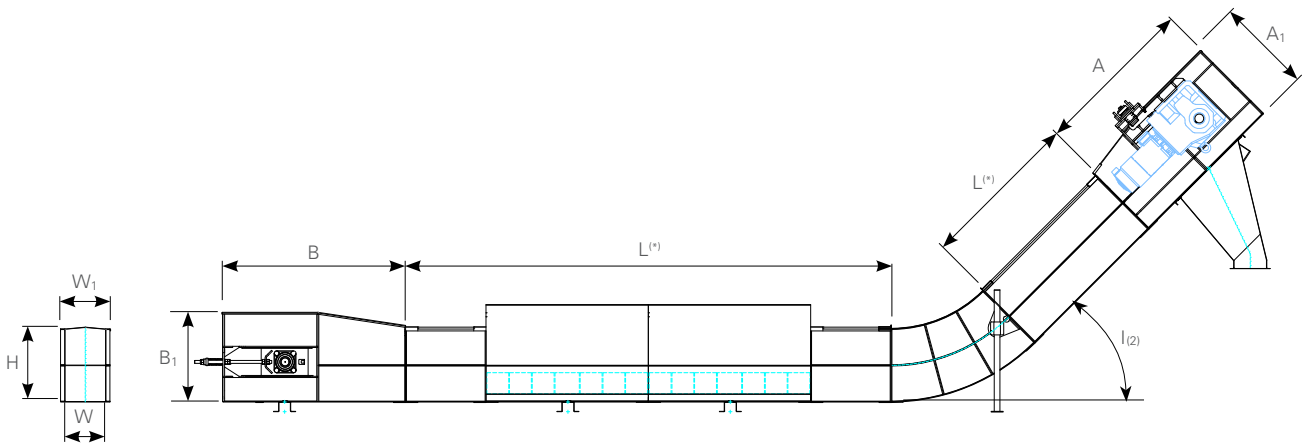

Ancillaries

A complete range of accessories for air filtering, grain cleaning and sampling are available for customers who want to complete their projects with high quality components, that integrate perfectly with AGI PTM equipment.

- Filters for intake pits
- Spot filters
- Centrifugal dust separators/cyclones
- Circuit sampling system
- Rotary drum pre-cleaners and sieve pre-cleaners
- Rotary distributors

Filters for Intake Pits

- High pressure filters have been studied to guarantee dust containment and mitigation during the unloading operations of truck trailers or train cars. The modular construction allows to match various intake-pit configurations with different lengths
- Excellent performances and very easy maintenance
- Discharging hopper for dust re-emission inside the main flow without weight losses
- Vertical filtering sleeves
- Built-in air suction fan and compressed air rinsing system for sleeves
- CE certification
- ATEX certification for installation in zone classified 22 (*)
- Water sprinkler to be connected to fire suppression system (*)



FILTER FOR INTAKE PIT



ROTARY DRUM PRE-CLEANERS



VIBRO SEPARATOR



VIBRO SEPARATOR WITH ASPIRATOR



SPOT FILTER

05 ANCILLARIES

Circular Filters

- High pressure filters with cylindrical steel body
- Discharge with conical bottom and rotary valve
- Discharge with flat bottom, scraper and rotary valve
- Vertical filtering sleeves;
- Compressed air rinsing system for sleeves
- Venting panels (*)
- CE certification
- ATEX certification for installation in zone classified 22 (*)

Spot Filters

- High pressure filters with a rectangular steel body designed for localized dust containment
- Vertical or horizontal design with filtering sleeves
- Special flange designed for an optimal integration with AGI PTM's handling equipment
- Excellent performances and very easy maintenance
- Compact design with built-in air suction fan and compressed air rinsing system for sleeves
- Dust re-emission inside the main flow without weight losses
- Hot dip galvanized, stainless steel (*) or powder coating surface finishing for milling applications (*)
- CE certification
- ATEX certification for installation in zone classified 22 (*)

Centrifugal Dust Separators

- Centrifugal dust separators/cyclones for a simple but effective dust containment
- Conical bottom for dust separation and discharge
- Completed with ductworks, suction fan and discharge rotary valves

OPTIONS (*)

Inline / Circuit Sampling System

- Circuit sampling systems allow for multiple samples to be easily taken from any bulk commodity. Installed in special points along the flow circuit (for example, at the discharging point of a dryer) and controlled by the plant's main PLC. The system gives the possibility of making sampling in a systematic way, at planned intervals, as needed
- Hot dip galvanization in compliance with standard EN ISO 1461
- Powder coating surface finishing for milling applications (*)
- Sturdy construction with welded reinforced frame
- CE certification of incorporation
- ATEX certification for installation in zone classified 22 (*)

Rotary Drum and Sieve Pre-cleaner

- Drum pre-cleaner for large impurities separation; various mesh size; internal chutes with AR steel or backed steel urethane sheet lining (*)
- Sieve pre-cleaner for fine and large impurities separation; vibrating interchangeable sieves with various mesh size for different crops qualities

Rotary Distributor

- Custom design rotary distributors with internal dust cleaning system
- Precise positioning with geared motor, sensors and electro pneumatic actuator
- AR steel, backed steel urethane sheet or ceramic lining (*)
- Flexible and automated operations thanks to dedicated PLC



Valves, Gates and Spouting

A complete range of accessories for detection and deviation of bulk products and for the connection of the various components of grain storage and processing plants, such as:

- Slides gates
- Diverter valves
- Absorber/dead boxes
- Square and round spouting

Slides Gates

- Hot dip galvanization in compliance with standard EN ISO 1461
- Powder coating surface finishing for milling applications (*)
- Sturdy construction with welded frame
- Manual, electric or electropneumatic control
- Blade position limit sensors
- CE certification of incorporation
- ATEX certification for installation in zone classified 22 (*)

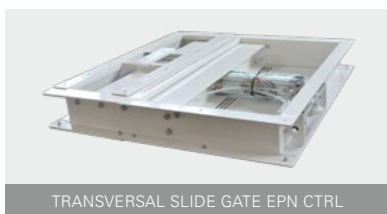

Diverter Valves

- Hot dip galvanization in compliance with standard EN ISO 1461
- Powder coating surface finishing for milling applications (*)
- Sturdy construction with welded frame
- Manual, electric or electropneumatic control
- Diverter blade position sensors
- CE certification of incorporation
- ATEX certification for installation in zone classified 22 (*)
- AR steel or urethane lining on the blade (*)

Cushion/Dead Boxes

- Hot dip galvanization in compliance with standard EN ISO 1461
- Powder coating surface finishing for milling applications (*)
- Vertical drop cushions
- Flow retarders
- Cushion elbows
- Self-cleaning design (*)
- AR steel or urethane lining (*)

Duct Works

- Hot dip galvanization in compliance with standard EN ISO 1461
- Powder coating surface finishing for milling applications (*)
- Square or round sections available
- AR steel or urethane lining (*)



OPTIONS (*)

06 VALVES, GATES & SPOUTING

STANDARD DUCTWORKS SECTIONS:

| MODEL | CAPACITY ⁽¹⁾ m ³ /h | MAIN DIMENSIONS | | | | | | |
|-------|--|-----------------|---------|---------|----------------------|---------|---------|---------|
| | | A mm | L mm | C mm | C ₁ mm | P mm | Ø mm | T mm |
| Q.160 | 60 | 160 | 215 | 10 | — | 195 | 10 | 3 |
| Q.200 | 120 | 200 | 266 | 15 | 48 | 140 | 10 | 3 |
| Q.250 | 205 | 250 | 316 | 15 | 48 | 95 | 10 | 3 |
| Q.300 | 295 | 300 | 390 | 20 | 65 | 110 | 12 | 3 |
| Q.350 | 425 | 350 | 440 | 20 | 60 | 140 | 12 | 4 |
| Q.400 | 550 | 400 | 490 | 20 | 65 | 160 | 12 | 4 |
| Q.450 | 700 | 450 | 540 | 20 | 70 | 180 | 12 | 4 |
| Q.500 | 870 | 500 | 590 | 20 | 65 | 140 | 12 | 5 |
| Q.550 | 1000 | 550 | 640 | 20 | 60 | 160 | 12 | 5 |
| Q.600 | 1200 | 600 | 690 | 20 | 45 | 140 | 12 | 5 |
| Q.650 | 1400 | 650 | 740 | 20 | 50 | 150 | 12 | 5 |
| Q.700 | 1650 | 700 | 790 | 20 | 55 | 160 | 12 | 5 |
| Q.750 | 1850 | 750 | 840 | 20 | 60 | 170 | 12 | 5 |
| Q.800 | 2100 | 800 | 890 | 20 | — | 170 | 12 | 5 |

| | CAPACITY ⁽¹⁾ m ³ /h | MAIN DIMENSIONS | |
|-------|--|-----------------|---------|
| | | D mm | T mm |
| T.159 | 55 | 159 | 3 |
| T.192 | 85 | 193,7 | 3 |
| T.219 | 115 | 219,1 | 3 |
| T.254 | 155 | 254 | 3 |
| T.273 | 190 | 273 | 3 |
| T.324 | 270 | 323,9 | 4 |
| T.355 | 340 | 355,6 | 4 |
| T.406 | 450 | 406,4 | 4 |

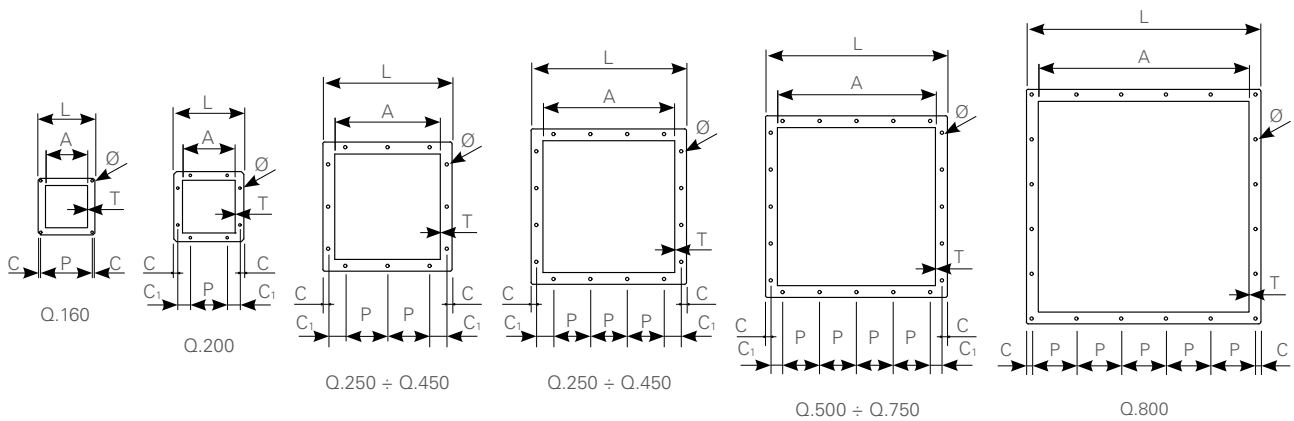
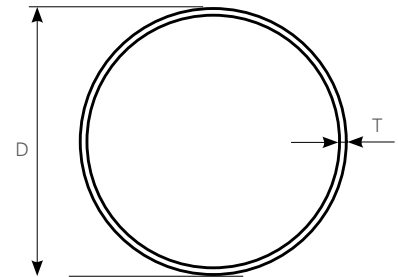

Engineering

AGI PTM firmly believes through correct and efficient design of handling systems, customers can benefit more from their storage, drying and processing plants.

We can offer our customers a broad range of engineering services to get the best from our handling equipment in terms of reliability, efficiency, durability and flexibility. Not only for a single machine, but also from the overall system.

No matter if our customers are small farmers, local traders, dealers or big international port terminals, AGI PTM engineering services can deliver complete integrated solutions for their handling equipment projects.

AGI PTM always provides customers with a balanced and efficient design of the plant, starting with a deep understanding of the customer needs.

Here below a brief list on the focus areas of our design study:

- Efficient and flexible receiving system design for trucks, trains or vessels
- Easy travel routes to minimize traffic and time losses during operations
- Durability and redundancy of the equipment, to minimize downtimes
- Flexibility, to operate two or more cycles at the same time maximizing productivity
- Power efficiency, cutting operational costs
- Capacity to handle and store two or more products at the same time
- A careful design of connection, to enhance durability of components and flexibility of operations
- An optimized planning of the civil works for an easy assembly, inspection, maintenance and service
- A look for future expansions to easily increase storing and handling capacity in case of business expansion

Upon request, AGI PTM can offer engineering services to their partners and customers at various levels, depending on their needs.

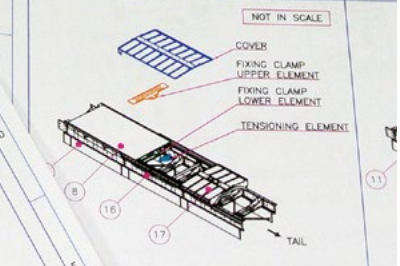
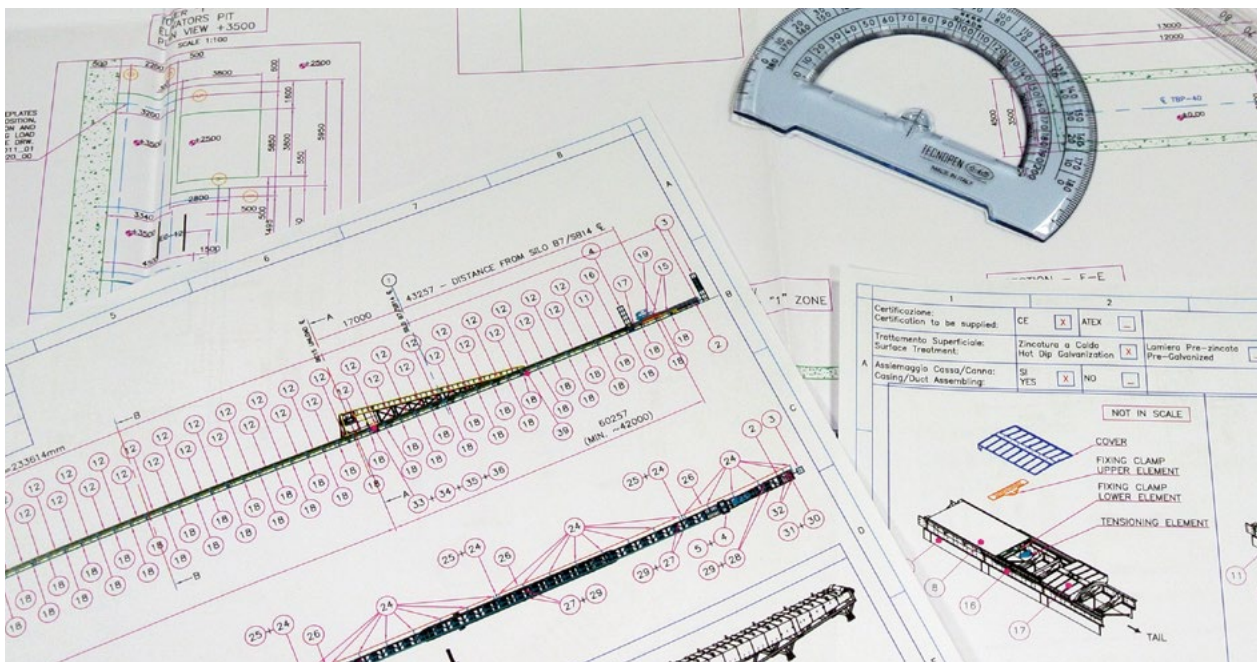

07 ENGINEERING

Standard Engineering Services

- Configuration drawing of every single piece of equipment. These drawings are shared in both cad and pdf format demonstrate the arrangement of the single machine together with a clear and comprehensive list of all main dimensions, connection interfaces and features.
- Additional technical data required to integrate AGI PTM's equipment on the storage plant, such as table of loads, information about electrical equipment, compressed air consumption and dust aspiration (where required).
- A comprehensive documentation with drawings and manuals for assembly, operation and maintenance. All documentation integrated with AGI PTM's code and labelling system to smoothly guide the assembling team through the installation process.

That is an additional feature that makes AGI PTM and our equipment unique.

Optional engineering services

At various levels, our customers can take advantage of our engineering services, starting from simple engineering consultancy to a more extensive collaboration of the entire design process. Below is a brief list of optional engineering services that we offer:

- Preliminary design and/or executive design for:
 - Process flow diagrams complete with all equipment, sensors, power and compressed air requirements
 - Layout and general arrangement drawings of the plant
 - Architectural civil works and reservation drawings to guide the design and calculation of the local civil engineering company/contractor.
- Co-engineering with customer contractors to collect information needed to comply with local regulations.
- In case of revamping, expansion or modernization we can review and advise about suitability and integrability of the handling system with the existing part of the installation.
- All drawings, upon request, available in both 2D and 3D format to help customers completing B.I.M. on their projects.

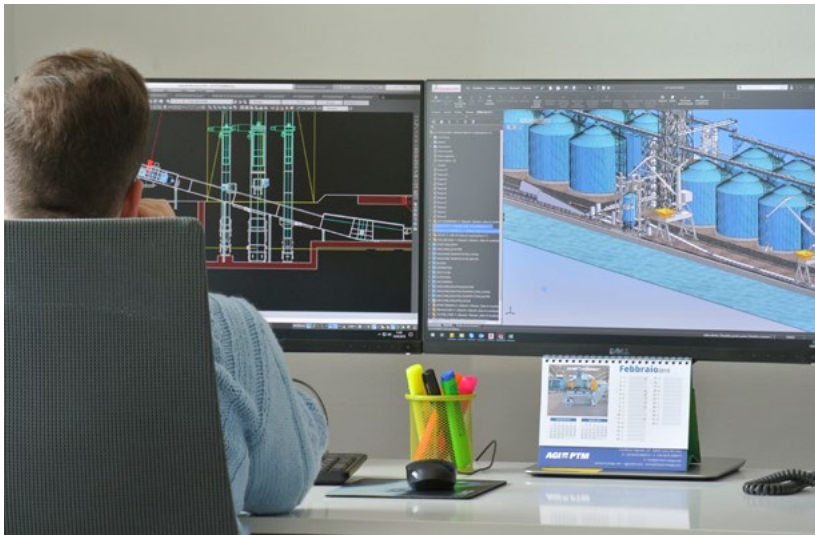
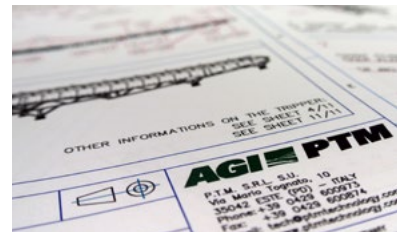

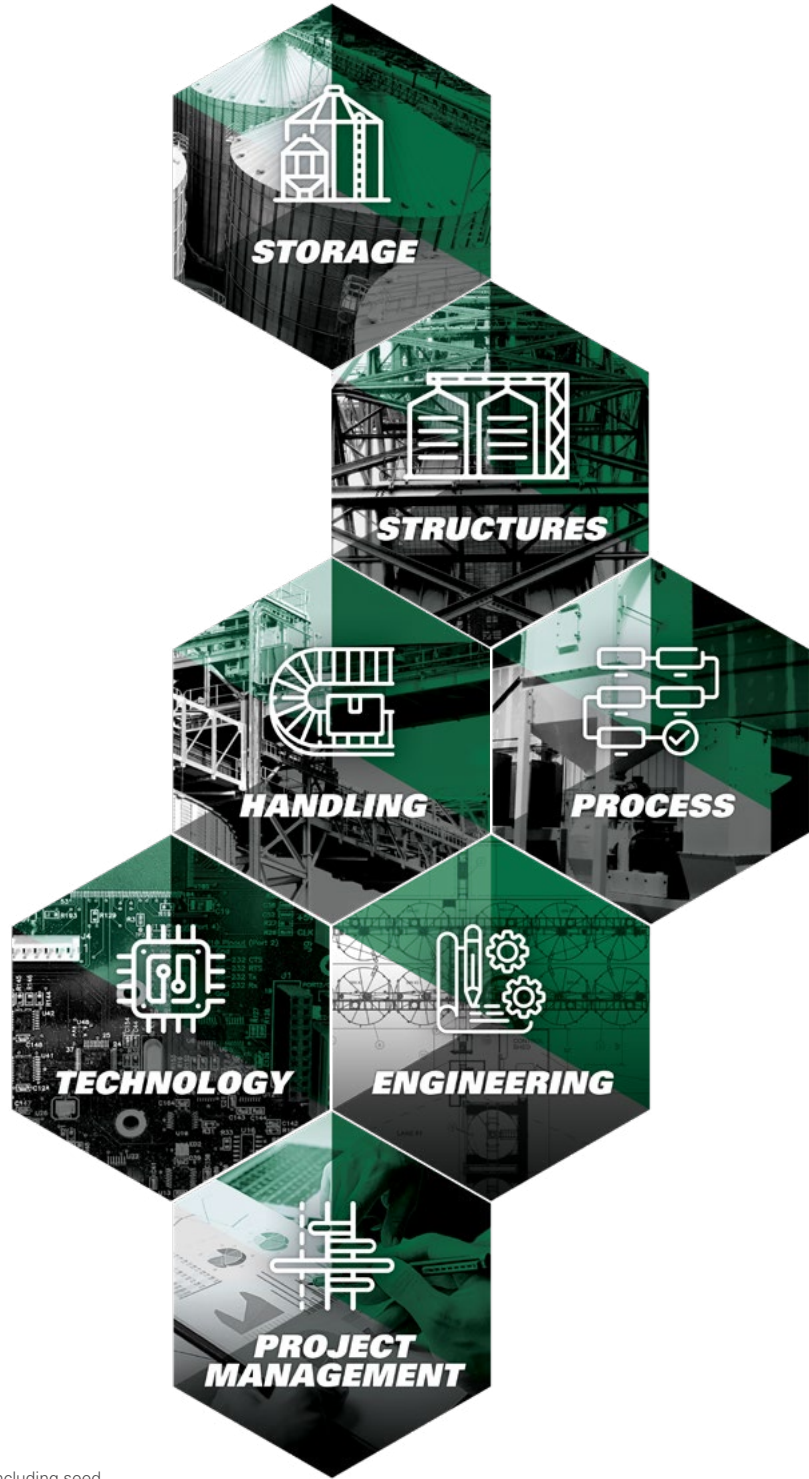

AGI EMEA is an AGI Brand.

AGI is a leading provider of equipment solutions for agriculture bulk commodities including seed, fertilizer, grain, and feed systems with a growing platform in providing equipment and solutions for food processing facilities. AGI has manufacturing facilities in Canada, the United States, the United Kingdom, Brazil, India and Italy and distributes its products globally.

AGI EMEA

AGI EMEA S.R.L. (Head Office) - Via Bertella 2 - 40064, Ozzano dell'Emilia (BO) - Italy | **P** +39 051 798 107 | **F** +39 051 796 300 | **E** emea@aggrowth.com
 AGI FRAME Plant - Via Barbariga 7 - 30032 Fiesso d'Artico (VE) - Italy | **P** +39 051 798 107 | **F** +39 051 796 300 | **E** frame@aggrowth.com
 AGI PTM Plant - Via Mario Tognato, 10 - 35042 Este (PD) - Italy | **P** +39 0429 600 973 | **F** +39 0429 600 874 | **E** ptm@aggrowth.com

Share Capital: € 500.000,00 | VAT ID: IT03293161208 | Companies' register: BO03293161208